

The Collection **6.0**

inverlight[®]
STAINLESS LIGHTING SOLUTIONS







Junkatree

Body completely made of stainless steel Aisi 316.
Sand-blasted polycarbonate diffuser.
Available with 1, 2 or 3 arms.

Corps complètement réalisé en acier inoxydable AISI 316.
Diffuseur en polycarbonate sablé.
Disponible à 1,2 ou 3 bras.

Corpo total inox Aisi 316.
Diffusore in polycarbonato sabbato.
Disponibile a 1, 2 o 3 braccia.



-  h 4.20 m **03**
-  h 3.20 m **03**
-  h 4.20 m **02**
-  h 3.20 m **02**
-  h 4.20 m **01**
-  h 3.20 m **01**

 **CE** IP 65 IK 09



JUNKATREE 01

LED 3000K \ 47W \ 6810lm \ 220-240V

h 3.20 m **20220**

h 4.20 m **20221**

 2G11 \ 1 x TC-L \ 55W \ 4800lm \ 220-240V

h 3.20 m **20201**

h 4.20 m **20202**

 2G11 \ 1 x TC-L \ 80W \ 6000lm \ 220-240V

h 3.20 m **20203**

h 4.20 m **20204**

JUNKATREE 02

2 x LED 3000K \ 47W \ 6810lm \ 220-240V

h 3.20 m **20222**

h 4.20 m **20223**

 2G11 \ 2 x TC-L \ 55W \ 4800lm \ 220-240V

h 3.20 m **20205**

h 4.20 m **20206**

 2G11 \ 2 x TC-L \ 80W \ 6000lm \ 220-240V

h 3.20 m **20207**

h 4.20 m **20208**

JUNKATREE 03

3 x LED 3000K \ 47W \ 6810lm \ 220-240V

h 3.20 m **20224**

h 4.20 m **20225**

 2G11 \ 3 x TC-L \ 55W \ 4800lm \ 220-240V

h 3.20 m **20209**

h 4.20 m **20210**

 2G11 \ 3 x TC-L \ 80W \ 6000lm \ 220-240V

h 3.20 m **20211**

h 4.20 m **20212**

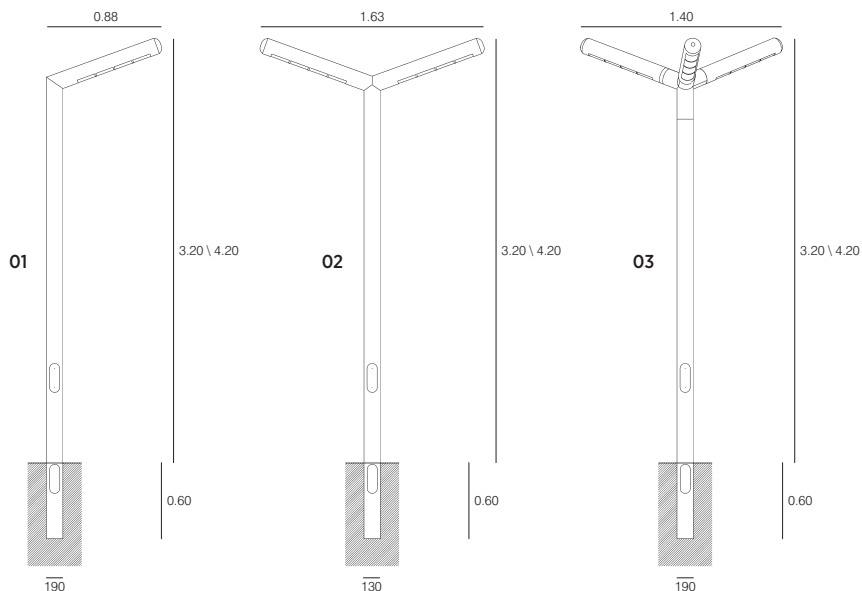



via P. Stucchi, 2 \ 20872 Cornate d'Adda (MB) Italy
tel. +39 039 6060754 \ Fax +39 039 6887843
www.inverlight.it \ info@inverlight.it